

# ikizler

"worth the light"

## Icon Industrial Lighting

06152



CE

İç mekan

220-240V  
50/60Hz

Ra≥80

IP  
65IK  
08

LED

max  
+40  
°C°C  
-20  
min

Ürün Kodu

Product Code

Güç

Power  
(W)

Ø D

(mm)

H

(mm)

Işık Akısı

Light Flux  
(lm)

Renk Sıcaklığı

Color Temperature  
(K)

max

min

kg

Ürün Kodu Product Code	Güç Power (W)	Ø D (mm)	H (mm)	Işık Akısı Light Flux (lm)	Renk Sıcaklığı Color Temperature (K)	max min	kg
06152.34.30.013/40.017	13	325	100	1403/1516	3000/4000	-20C°/+40C°	1.3
06152.34.30.0181/40.019	18	325	100	1944/2100	3000/4000	-20C°/+40C°	1.3
06152.34.30.031/40.032	25	325	100	3000/3200	3000/4000	-20C°/+40C°	1.3

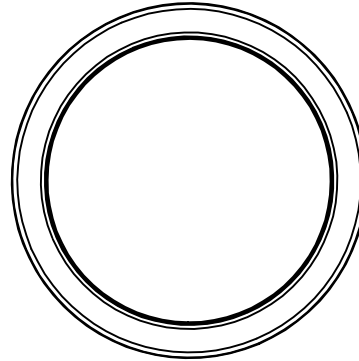
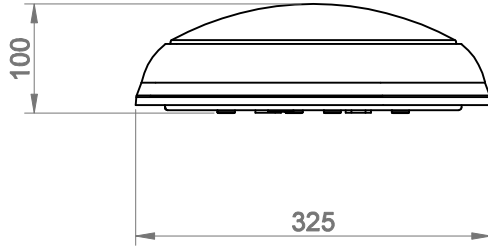

### ! UYARI

- Bakım ve montaj yalnızca kalifiye personel tarafından yapılmalıdır.
- Servis yapmadan önce bağlantıyı kesin.
- Armatür, alçak gerilim beslemesi ile kontrol iletkenleri arasında temel izolasyona sahiptir.
- Armatür termal yalıtım malzemesi ile kaplanmaya uygun değildir.
- Bina içi ve bina dışı kullanıma uygundur.
- Armatürler iletken yüzeylere montaj yapılamaz.
- Onarım ve bakım sırasında yalnızca orijinal parçalar kullanılmalıdır.
- Eğer armatürde sonradan değişiklik yapılırsa, değişiklikten sorumlu, üretici olarak kabul edilecektir.
- Üretici uygunsuz kullanım ya da uygulama sebebiyle meydana gelen hasar konusunda sorumluluk kabul etmez.

- Lütfen elektrikli ve elektronik ürünler için yerel atık imha, ayırma ve toplama sistemi hakkında bilgi edinin. Lütfen yerel kurallarınıza göre hareket edin ve eski ürününüzü normal ev atığınızla birlikte atmayın. Ürününüzün doğru şekilde imha edilmesi, çevre ve insan sağlığı için olası olumsuz sonuçları önlemeye yardımcı olacaktır.

### ! WARNING

- Installation / maintenance only by skilled personnel.
- Disconnect before servicing.
- Luminaire has basic insulation between low voltage supply and control conductors.
- Luminaire is not suitable for covering with thermal insulation material.
- Suitable for indoor and outdoor use.
- The luminaires are not allowed to be mounted on conductive surface.
- During overhaul / maintenance only use original parts.
- If any luminaire is subsequently modified, the person, responsible for the modification shall be considered the manufacturer.
- The manufacturer bears no liability for damage caused by inappropriate use or application.

- Please inform yourself about the local waste disposal, separation and collection system for electrical and electronic products. Please act according to your local rules and do not dispose of your old product with your normal household waste. The correct disposal of our product will help prevent potential negative consequences for the environment and human health.

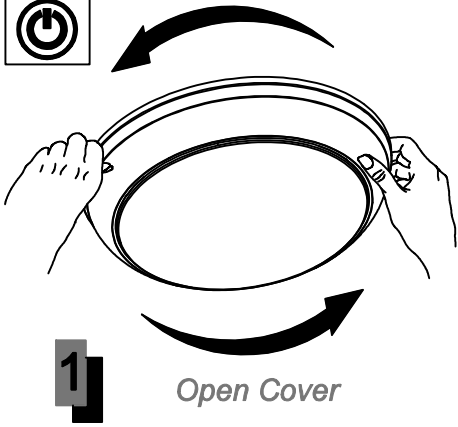

1

Open Cover

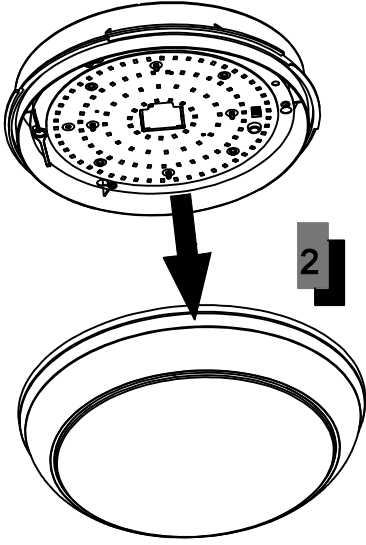

2

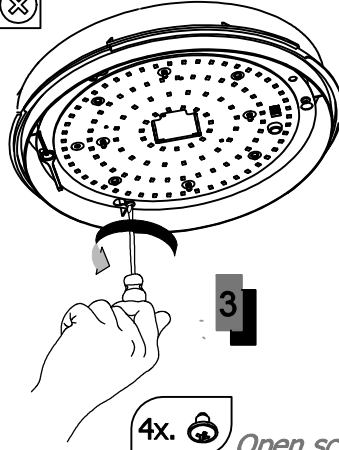
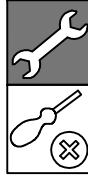

3

4x. Open screw

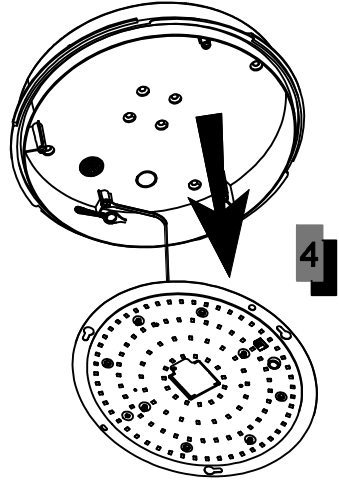

4

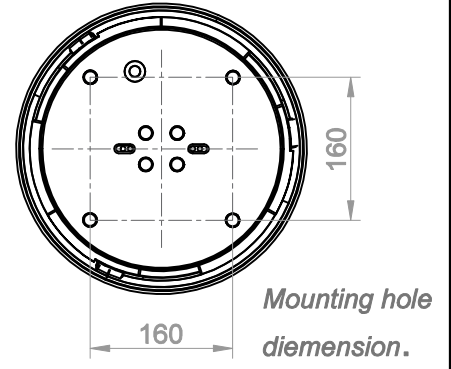

Mounting hole dimension.

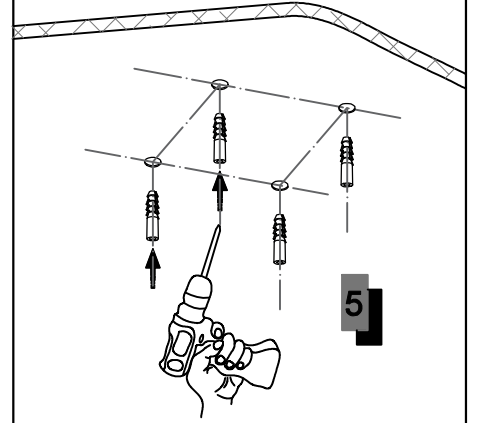

5

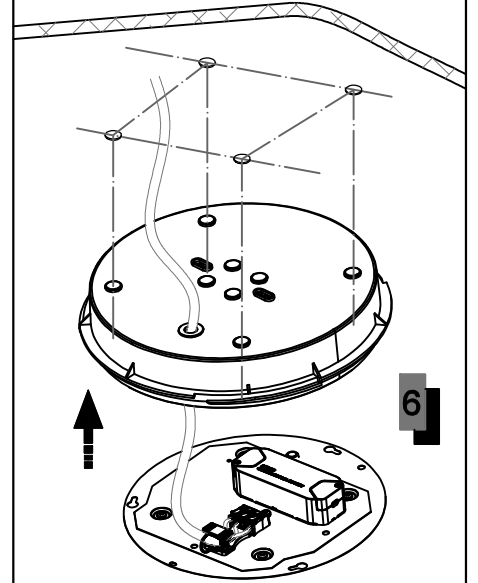

6

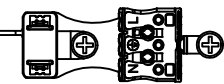
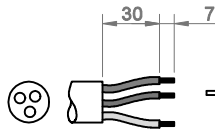
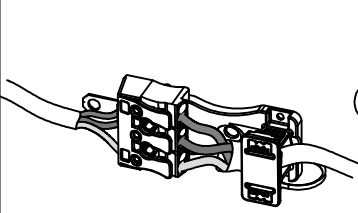

- (L) Black
- (G) Ground
- (N) Blue

H07RN-F  
Min. 3x0.75mm<sup>2</sup>  
Max. 3x2.50mm<sup>2</sup>  
Ø10- Ø12mm

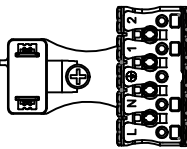
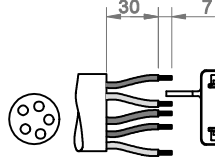
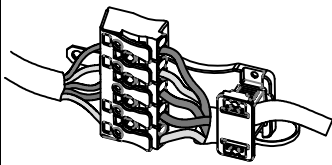

- (-) White
- (+) Red
- (G) Ground
- (N) Blue
- (L) Black

H07RN-F  
Min. 5x0.75mm<sup>2</sup>  
Max. 5x2.50mm<sup>2</sup>  
Ø10- Ø12mm

**(TR)** Armatürün harici bükülgen kablo veya kordonun hasar görmesi durumunda ; bir tehlike meydana gelmesini engellemek için yalnızca imalatçı veya onun yetkili servisi ya da eşdeğer nitelikli kalifiye personel tarafından değiştirilmesi gerekir.

**(ENG)** If the external flexible cable or cord of this luminaire is damaged, it shall be exclusively replaced by the manufacturer or his service agent or a similar qualified person in order to avoid a hazard.

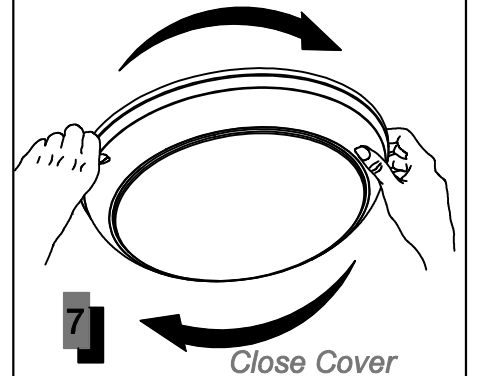

7

Close Cover

**(TR)** Verilen bilgiler önceden bildirmeksizin değiştirilebilir. Laboratuvar koşullarında ölçülen tüm değerler tasarım veya tipik değerlerdir, ikizler aydınlatma bu performansın son kullanım koşullarında elde edileceğini garanti vermez.

**(ENG)** Information provided is subject to change without notice. All values are design or typical values when measured under laboratory conditions and ikizler lighting makes no warranty or guarantee, express or implied, that such performance will be obtained under end-use conditions.