

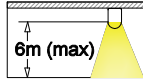

DRAX A-BATWING

Industrial Luminaire

07112

IP
65220-240V
50/60HzRa \geq 80

Ta=25°C

DALI

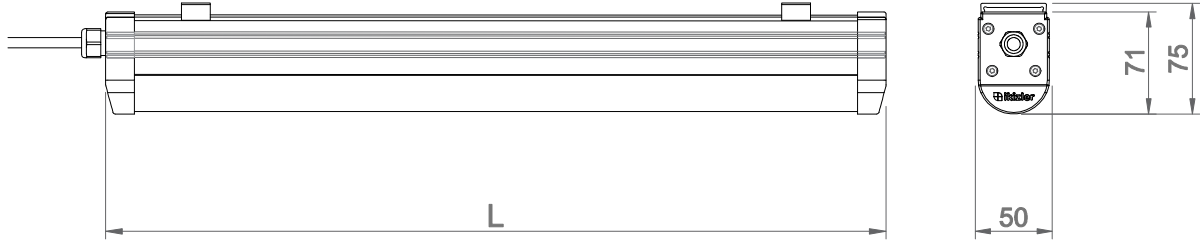

! UYARI

- Bakım, montaj ve elektrik bağlantıları yalnızca kalifiye personel tarafından yapılmalıdır.
- Armatür montaj veya ışık kaynağını değiştirme işleminden önce, elektrik bağlantısı kesilmelidir.
- Armatür termal yalıtım malzemesi ile kaplanmaya uygun değildir.
- Armatürler iletken yüzeylere montaj yapılamaz.
- Onarım ve bakım sırasında yalnızca orjinal parçalar kullanılmalıdır.
- Eğer armatürde sonradan değişiklik yapılırsa, değişiklikten sorumlu tüketici kabul edilecektir.
- Üretici uygulamalardan kaynaklı hatalardan, sorumlu değildir.

! WARNING

- Maintenance, installation and electrical connections should be performed by qualified personnel.
- The electrical connection must be disconnected before fitting the fitting or replacing the light source.
- Luminaire is not suitable for coating with thermal insulation material.
- Armatures can not be mounted on conductive surfaces.
- Only original parts should be used during repair and maintenance.
- If the luminaire is subsequently modified, the consumer responsible for the change will be accepted.
- The manufacturer is not responsible for any errors resulting from applications.

Ø8 mm

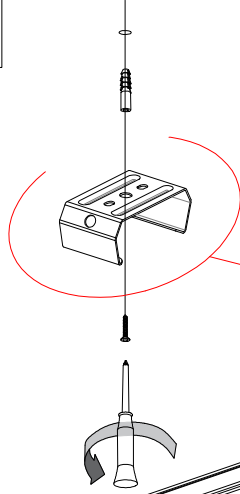

* 1a.
Sarkit opsiyonu

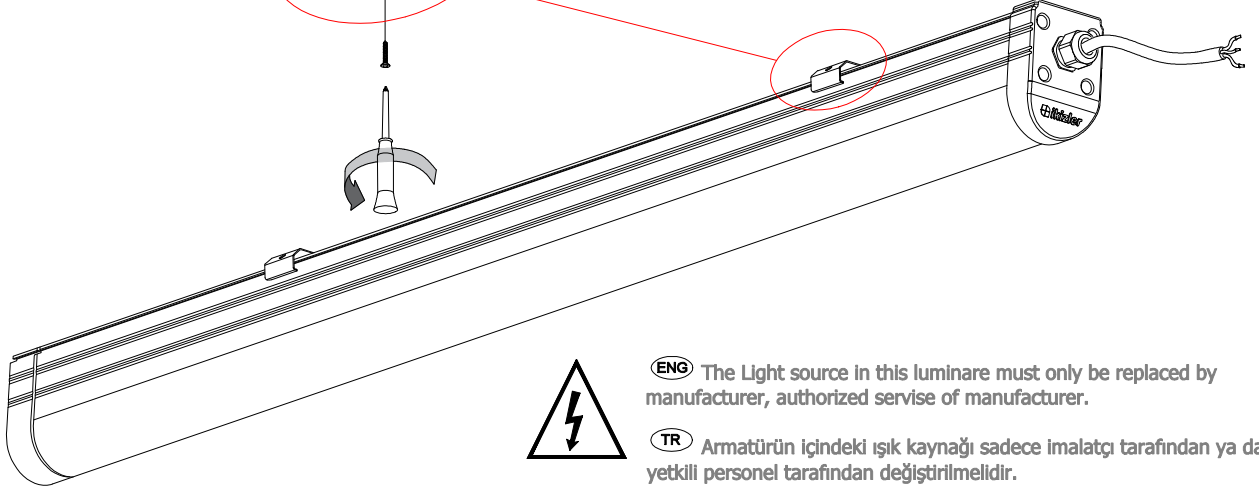

(ENG) The Light source in this luminaire must only be replaced by manufacturer, authorized service of manufacturer.

(TR) Armatürün içindeki ışık kaynağı sadece imalatçı tarafından ya da yetkili personel tarafından değiştirilmelidir.

*1b. Sıva üstü opsiyonu

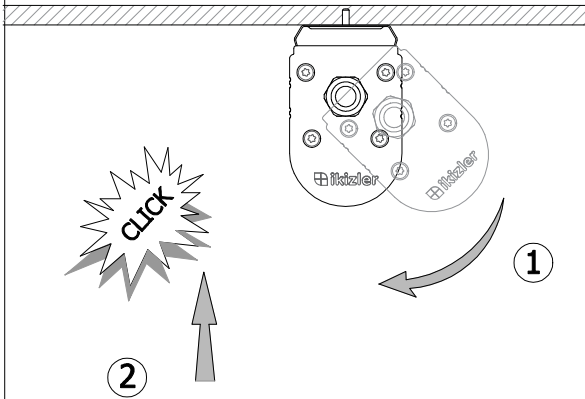

* Montaj Aparatı

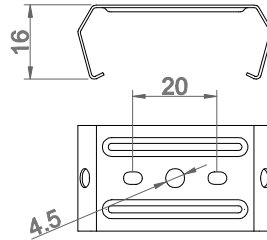

* PG11 Rakor

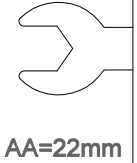
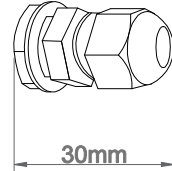

4.

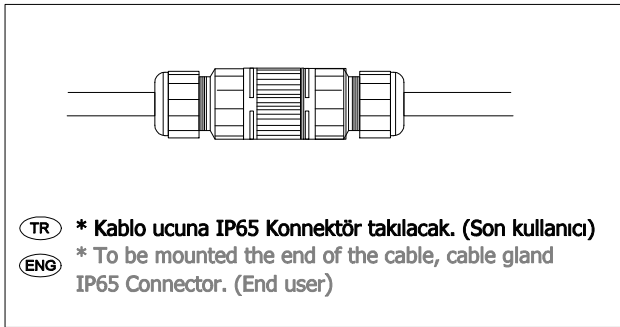

(TR) * Kablo ucuna IP65 Konnektör takılacak. (Son kullanıcı)
(ENG) * To be mounted the end of the cable, cable gland IP65 Connector. (End user)

3x1-1.5 mm
min.Ø8,5 max Ø12

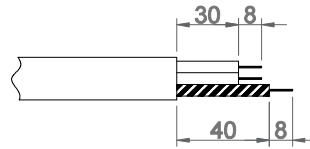

5 x 1-1.5mm²

DALI system

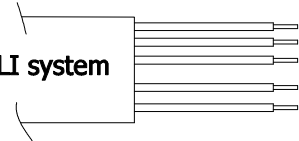

(L)
(N)
(+)
DA/N
DA/Ls

(TR) Bu armatürün harici bükülgen kablo veya kordonun hasar görmesi durumunda ; bir tehlike meydana gelmesini engellemek için yalnızca imalatçı veya onun yetkili servisi ya da eşdeğer nitelikli kalifiye personel tarafından değiştirilmesi gerekir.

(ENG) In case of getting damage of flexible cable and cord of this luminaire; to prevent a danger arising, it must be replaced by only manufacturer or their authorized service.

(TR) Verilen bilgiler önceden bildirilmeksizin değiştirilebilir. Laboratuvar koşullarında ölçülen tüm değerler tasarım veya tipik değerlerdir, ikizler aydınlatma bu performansın son kullanım koşullarında elde edileceğini garanti vermez.

(ENG) Information provided is subject to change without notice. All values are design or typical values when measured under laboratory conditions and ikizler lighting makes no warranty or guarantee, express or implied, that such performance will be obtained under end-use conditions.