

Tiny 040

Indoor Lighting - Spot Lighting



Colour Options



Ral 9016

TECHNICAL INFORMATION

Housing	Aluminum Injection
Reflector	Metallized Surface Optics
Diffuser	Transparent Lens
Paint	Electrostatic Powder Paint

OPTICAL SPECIFICATIONS

Light Distribution	Symmetrical
Light Output Angle	39°
UGR Value	UGR ≤ 19
CRI	CRI ≥ 80
Color Bin Value	Mc Adams ≤ 3

ELECTRICAL

Power (W)	2,5W-5W
Power Factor	>0.95 (5W) / >0.5(2,5W)
Light Source	COB LED
Cabling	Halojen-Free
Input Voltage	220-240V AC / 50-60 Hz
LED Driver	High Efficiency Constant Current Output
Ambient Temperature	-20°C / +50°C
LED Lifetime L80B50	>50.000 Hour

OPTIONAL

2700K ~ 6500K
CRI > 90
Plug-in Energy Input Connector

ASSEMBLY

Installation Type Under Plaster
Mounting Steel Spring
Apparatus

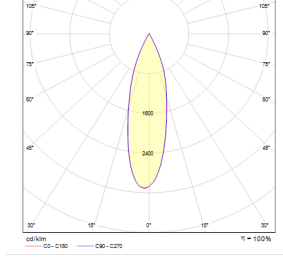
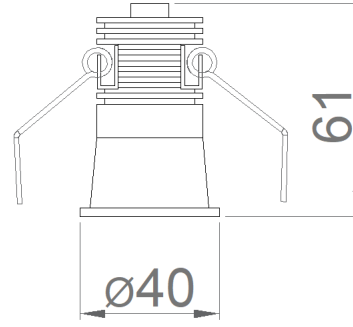

Order Code	W	Lm	Angle	CCT	CRI	ØxH (mm)	Ceiling Cutting (mm)	Kg
05112.03.40.001	2,5	205	39°	4000	Ra>80	40x61	Ø35	0,06

