

Snow-023 IP65

Indoor Lighting - Downlight Lighting



Colour Options



TECHNICAL INFORMATION

Housing	Aluminum Injection
Diffuser	Opal Diffuser + Tempered Clear Glass
Frame	Aluminum Injection
Paint	Electrostatic Powder Paint
Gasket	Transparent Silicone

OPTICAL SPECIFICATIONS

Optics	Symmetrical
Light Output Angle	110°
UGR Value	UGR ≤ 22
CRI	CRI ≥ 80
Color Bin Value	Mc Adams ≤ 3

ELECTRICAL

Power (W)	26-30W
Power Factor	>0.95
Light Source	SMD Mid Power LED
Cabling	Halojen-Free
Input Voltage	220-240V AC / 50-60 Hz
LED Driver	High Efficiency Constant Current Output
Ambient Temperature	-20°C / +50°C
LED Lifetime L80B50	>50.000 Hour

OPTIONAL

- DALI	- 1-10V DIM
- Tunable White	- Emergency Lighting Unit
- Microprismatic Diffuser (UGR < 19)	- CRI > 90
- 2700K ~ 6500K	- Different RAL Color Options
- Plug-in Energy Input Connector	- Class-I Protection Class
- PIR Sensor	- AC-DC Supply(MBS)
- IP 65 Drive Box	

ASSEMBLY

Installation Type	Under Plaster
Mounting Apparatus	Steel Spring

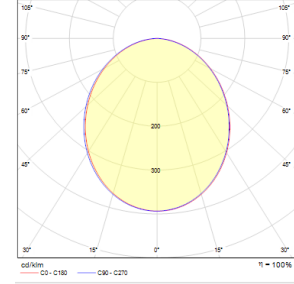
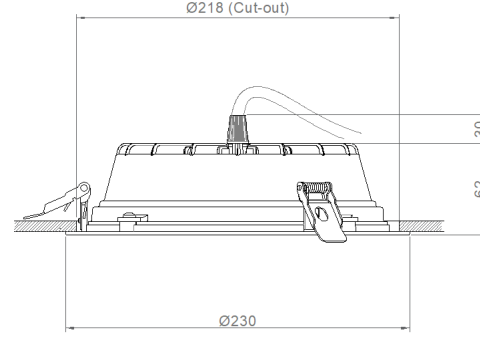

Order Code	W	Lm	CCT	CRI	Ceiling Cutting (mm)	Kg
05393.23.30.024	26	2450	3000	Ra>80	Ø218	0,90

Verilen tüm elektriksel değerler nominal değerlerdir. Işık akısı ve bağlı elektrik yükü +/- %10 luk bir başlangıç toleransına tabidir. Renk sıcaklığı toleransı: +/-150 K. Katalogta ve web sitesinde yer alan teknik parametreler ve ürün kodlarını içeren bilgiler, projelere göre yapılan kişiselleştirmelerden dolayı standart ürünlerden farklılık gösterebilir. İkiizler Aydınlatma, ürünlerde haber vermeden değişiklik yapma hakkına sahiptir.

