

# Corvus-S 900

Indoor Lighting - Pendant Lighting

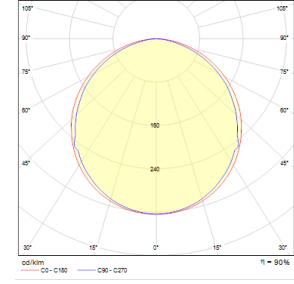

Colour Options

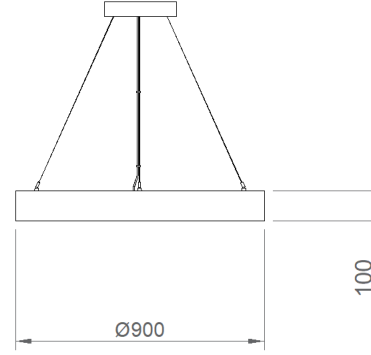

Order Code	W	Lm	CCT	CRI	ØxH (mm)	Kg
03170.90.30.107	69	6800	3000	Ra>80	900x100	5,5
03170.90.40.111	69	6900	4000	Ra>80	900x100	5,5

## TECHNICAL INFORMATION

<b>Housing</b>	Extruded Aluminum Profile
<b>Diffuser</b>	Highly Transmissive Opal Diffuser
<b>Paint</b>	Electrostatic Powder Paint

## OPTICAL SPECIFICATIONS

<b>Optics</b>	Symmetrical
<b>Light Output Angle</b>	120°
<b>UGR Value</b>	UGR ≤ 22
<b>CRI</b>	CRI ≥ 80
<b>Color Bin Value</b>	Mc Adams ≤ 3

## ELECTRICAL

<b>Power (W)</b>	69W
<b>Power Factor</b>	>0.95
<b>Light Source</b>	SMD Mid Power LED
<b>Cabling</b>	Halogen-Free
<b>Input Voltage</b>	220-240V AC / 50-60 Hz
<b>LED Driver</b>	High Efficiency Constant Current Output
<b>Ambient Temperature</b>	-20°C / +50°C
<b>LED Lifetime L80B50</b>	>50.000 Hour

## OPTIONAL

- DALI	- 1-10V DIM
- Tunable White	- Emergency Lighting Unit
- CRI > 90	- 2700K ~ 6500K
- Different RAL Color Options	- Plug-in Energy Input Connector
- Class-II Protection Class	- AC-DC Supply(MBS)

## ASSEMBLY

<b>Installation Type</b>	Pendant
<b>Mounting Apparatus</b>	Height Adjustable Steel Wire

