

Run

Indoor Lighting - Emergency Lighting and Directional Luminaire

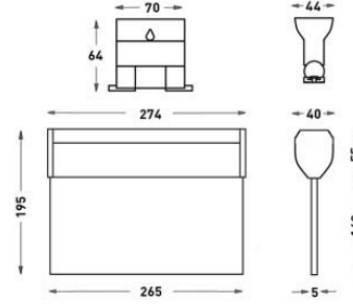

Order Code	W	How to use	Battery	WxHxL (mm)	Kg
80311.010.015-IK15	4,87	Tek Yüzlü	3H	40X195X265	0,665

TECHNICAL INFORMATION

Housing	Aluminium
Frame	Foil Printed Acrylic Lens
Diffuser	Transparent Plexiglass
Paint	Anodizing
Side Cover	Polycarbon

OPTICAL SPECIFICATIONS

ELECTRICAL

Power (W)	4,87W
Power Factor	>0.90
Light Source	SMD Mid Power LED
Input Voltage	220-240V AC / 50-60 Hz
LED Driver	High Efficiency Constant Current Output Rail
Ambient Temperature	0°C / +40°C
LED Lifetime L80B50	>50.000 Hour
Battery	Ni-Cd

OPTIONAL

- Emergency Test Button	- Battery Charge Indicator with Green LED
- 2700K ~ 6500K	- Class-II Protection Class

ASSEMBLY

Installation Type	Under Plaster, Surface Mounted
Mounting Apparatus	Metal Bracket

